

CR16 Audio/Video Multizone Control System



CR16

The lightning flash with arrowhead, within an equilateral triangle, is intended to alert the user to the presence of uninsulated "dangerous voltage" within the product's enclosure that may be of sufficient magnitude to constitute a risk of electric shock to persons.



AVIS RISQUE DE CHOC ELECTRIQUE - NE PAS OUVRIR.

The exclamation point within an equilateral triangle is intended to alert the user to the presence of important operating and maintenance (servicing) instructions in the literature accompanying the appliance.

WARNING - TO REDUCE RISK OF FIRE OR ELECTRICAL SHOCK, DO NOT EXPOSE THIS EQUIPMENT TO RAIN OR MOISTURE.

NO USER-SERVICEABLE PARTS INSIDE. REFER SERVICING TO QUALIFIED PERSONNEL.

To prevent the risk of electric shock, do not remove cover or back. No user serviceable parts inside.

IMPORTANT SAFETY INSTRUCTIONS!

PLEASE READ THEM BEFORE OPERATING THIS EQUIPMENT.

General:

1. Read these instructions.
2. Keep these instructions.
3. Heed all warnings.
4. Follow all instructions.
5. **Warning: To reduce risk of fire or electrical shock, do not expose this equipment to rain or moisture. This unit is capable of producing high sound pressure levels. Continued exposure to high sound pressure levels can cause permanent hearing impairment or loss. User caution is advised and ear protection is recommended when playing at high volumes.**
6. **Caution: to prevent electrical shock do not use this (polarized) plug with an extension cord, receptacle or other outlet unless the blades can be fully inserted to prevent blade exposure.**
Attention: pour prevenir les chocs electriques pas utiliser cette fiche polarisee avec un prolongateur, une prise de courant ou un autre sortie de courant, sauf si les lames peuvent etre inserees afond ans en laisser aucune partie a decouvert.
7. Unplug this apparatus during lightning storms or when unused for long periods of time.
8. Only use attachments/accessories specified by the manufacturer.

Installation:

9. The equipment shall be installed near the AC Socket Outlet and the disconnect device shall be easily accessible.
10. Do not block any ventilation openings. Install in accordance with the manufacturer's instructions.
11. Do not install near any heat sources such as radiators, heat registers, stoves, or other equipment (including amplifiers) that produce heat.
12. Do not use this equipment near water.
13. Do not expose this equipment to dripping or splashing and ensure that no objects filled with liquids, such as vases, are placed on the equipment.
14. Use only with the cart, stand, tripod, bracket, or table specified by the manufacturer, or sold with the equipment. When a cart is used, use caution when moving the cart/equipment combination to avoid injury from tip-over.



Connection:

15. Connect this equipment only to the type of AC power source as marked on the unit.
16. Protect the power cord from being walked on or pinched particularly at plugs, convenience receptacles, and the point where they exit from the equipment.
17. Do not defeat the safety purpose of the polarized or grounding-type plug.

A polarized plug has two blades with one wider than the other. A grounding type plug has two blades and a third grounding prong. The wide blade or the third prong are provided for your safety. If the provided plug does not fit into your outlet, consult an electrician for replacement of the obsolete outlet.

18. Do not overload wall outlets, extension cords or integral convenience receptacles as this can result in a risk of fire or electric shock.
19. To completely disconnect this equipment from the AC Mains, disconnect the power supply cord plug from the AC receptacle.

Care of Equipment:

20. Clean only with a dry cloth.
21. Do not permit objects or liquids of any kind to be pushed, spilled and/or fall into the equipment through enclosure openings.
22. Unplug the power cord from the AC power outlet when left unused for a long period of time.

Repair of Equipment:

23. Refer all servicing to qualified service personnel. Servicing is required when the equipment has been damaged in any way, such as power-supply cord or plug is damaged, liquid has been spilled or objects have fallen into the equipment, the equipment has been exposed to rain or moisture, does not operate normally, or has been dropped.
24. Do not attempt to service beyond that described in the operating instructions. All other service should be referred to qualified service personnel.
25. When replacement parts are required, be sure the service technician has used replacement parts specified by McIntosh or have the same characteristics as the original part. Unauthorized substitutions may result in fire, electric shock, or other hazards.
26. Upon completion of any service or repairs to this product, ask the service technician to perform safety checks to determine that the product is in proper operating condition.

Thank You

Your decision to own this McIntosh CR16 Audio/Video Control System ranks you at the very top among discriminating music listeners. You now have "The Best." The McIntosh dedication to "Quality," is assurance that you will receive many years of musical enjoyment from this unit.

Please take a short time to read the information in this manual. We want you to be as familiar as possible with all the features and functions of your new McIntosh.

Please Take A Moment

The serial number, purchase date and McIntosh dealer name are important to you for possible insurance claim or future service. The spaces below have been provided for you to record that information:

Serial Number: _____

Purchase Date: _____

Dealer Name: _____

Technical Assistance

If at any time you have questions about your McIntosh product, contact your McIntosh dealer who is familiar with your McIntosh equipment and any other brands that may be part of your system. If you or your dealer wish additional help concerning a suspected problem, you can receive technical assistance for all McIntosh products at:

McIntosh Laboratory, Inc.
2 Chambers Street
Binghamton, New York 13903
Phone: 607-723-1545
Fax: 607-723-3636

Customer Service

If it is determined that your McIntosh product is in need of repair, you can return it to your dealer. You can also return it to the McIntosh Laboratory Service Repair department. For assistance on factory repair return procedure, contact the McIntosh Repair Department at:

McIntosh Laboratory, Inc.
2 Chambers Street
Binghamton, New York 13903
Phone: 607-723-3515
Fax: 607-723-1917

Controller Input B (DB37 Connector):

- | | | |
|-----------------|-----------------|-----------------|
| 1. Accessory-On | 14. LV-Left | 26. CD-Data |
| 2. SYS-Off | 15. TV-Left | 27. N/C |
| 3. Sum Data | 16. Aux-Left | 28. N/C |
| 4. DVD-Data | 17. Tape 1-Left | 29. Ground |
| 5. LV-Data | 18. Tuner-Left | 30. DVD-Right |
| 6. Aux-Data | 19. CD-Left | 31. VCR-Right |
| 7. Tuner-Data | 20. Video Power | 32. LV-Right |
| 8. N/C | 21. Ground | 33. TV-Right |
| 9. N/C | 22. Home-Data | 34. Aux-Right |
| 10. N/C | 23. VCR-Data | 35. Tape-Right |
| 11. Ground | 24. TV-Data | 36. Tuner-Right |
| 12. DVD-Left | 25. Tape-Data | 37. CD-Right |
| 13. VCR-Left | | |

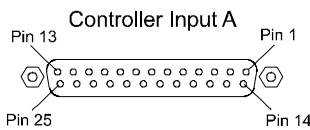

Controller Input A (DB25 Connector):

- | | | |
|----------------|------------------|------------------|
| 1. Aux-Left | 10. N/C | 19. CD-Right |
| 2. TV-Left | 11. CD 2-Data | 20. SYS-Off |
| 3. N/C | 12. Tape 1-Data | 21. Accessory On |
| 4. Tape 1-Left | 13. Video Power | 22. Aux-Data |
| 5. Tuner-Left | 14. Aux-Right | 23. Sum Data |
| 6. CD 2-Left | 15. TV-Right | 24. N/C |
| 7. Ground | 16. N/C | 25. Home Data |
| 8. Ground | 17. Tape 1-Right | |
| 9. Tuner-Data | 18. Tuner-Right | |

9. When connecting a dedicated source component to the ZONE AUX IN Jacks, it is important to also connect a data cable to the ZONE AUX IN DATA Jack. If a McIntosh Component without a Data Port or a non-McIntosh Component is connected to the ZONE AUX IN Jacks, it is important to insert a stereo mini phone plug with the tip to ring shorted together. This allows the CR16 to process the signal present at the ZONE AUX IN Jacks instead of the source connected to the regular AUDIO/VIDEO INPUT Jacks, for that Zone only.

Connector Information

Keypad Terminal Connector

To use a WK-3 or WK-4 keypad, connect the shield and four leads of a shielded 4 conductor cable to a keypad terminal connector, according to the numbers listed below. There is a similar numbered connector built-in to each keypad.

- Supply Voltage Positive
- Supply Voltage Negative
- Cable Shield
- Signal Data
- Signal Data Gnd.

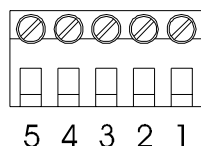

Balanced Outputs Din Connector Pin Layout

Note: Refer to figure 1.

- Left Channel (-)
- (Not used)
- Right Channel(-)
- Left Channel Gnd.
- Right Channel Gnd.
- Left Channel (+)
- Right Channel (+)

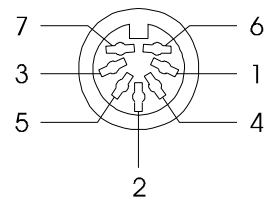

Figure 1

Multi-Channel Din Connector Pin Layout

Note: Refer to figure 1.

- | | |
|----------------------|----------------------|
| 1. Zone 3-Pwr. Ctrl. | 5. Video Power |
| 2. Zone 1-Pwr. Ctrl. | 6. Zone 4-Pwr. Ctrl. |
| 3. Pwr. Ctrl. (Main) | 7. Gnd. |
| 4. Zone 2-Pwr. Ctrl. | |

Pwr. Ctrl. Din Connector Pin Layout

Note: Refer to figure 1.

- | | |
|----------------------|----------------------|
| 1. Zone 3-Pwr. Ctrl. | 5. Video Power |
| 2. Zone 1-Pwr. Ctrl. | 6. Zone 4-Pwr. Ctrl. |
| 3. Power On Output | 7. Gnd. |
| 4. Zone 2-Pwr. Ctrl. | |

RS 232 DB9 Connector Pin Layout

- | | |
|---------------------------|--------|
| 1. N/C | 6. N/C |
| 2. Data Out (TXD)In (RXD) | 7. N/C |
| 3. Data In (RXD) | 8. N/C |
| 4. N/C | 9. N/C |
| 5. Gnd. | |

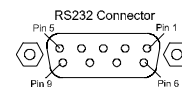

Multi-Channel Amp DB25 Connector Pin Layout

- | | |
|-----------------------|----------------------------|
| 1. Zone 2-Left | 14. Zone 2-Left Gnd. |
| 2. Zone 1-Left | 15. Zone 1-Left Gnd. |
| 3. Zone 2-Right | 16. Zone 2-Right Gnd. |
| 4. Zone 3-Left | 17. Zone 3-Left Gnd. |
| 5. Zone 1-Right | 18. Zone 1-Right Gnd. |
| 6. Zone 3-Right | 19. Zone 3-Right Gnd. |
| 7. Zone 4-Left | 20. Zone 4-Left Gnd. |
| 8. Zone 4-Right | 21. Zone 4-Right Gnd. |
| 9. N/C | 22. N/C |
| 10. N/C | 23. Zone 3-Pwr. Ctrl. |
| 11. Zone 1-Pwr. Ctrl. | 24. Zone 4-Pwr. Ctrl. |
| 12. Zone 2-Pwr. Ctrl. | 25. Pwr. Ctrl. Gnd. (Main) |
| 13. Pwr. Ctrl. (Main) | |

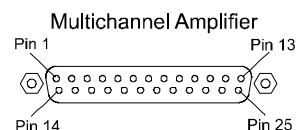

Introduction

Now you can take advantage of traditional McIntosh standards of excellence in the CR16 advanced design Audio/Video Multizone Control System. You only need to push a button on a remote controller or a keypad to enjoy music and video programs throughout your home with McIntosh quality and reliability. The heart of the CR16 consists of four, independent, remotely controlled stereo preamplifiers.

Performance Features

- **Four Independent Preamplifiers**

The CR16 consists of four independent stereo Audio/Video preamplifiers that can be remotely controlled from four separate zones. The front panel display shows the status of each zone.

- **Separate Programming**

Each of the four zones can be programmed from the CR16 front panel for selection of signal source and wake-up volume level.

- **Eight Source Selection**

Select any of four stereo audio/video signal sources, and four stereo audio signal sources in each zone using a Keypad or Remote Control.

- **Local Source Zone Selection**

An audio/video or audio only signal source component can be dedicated to operate only in a specific zone.

- **Independent Zone Tone Adjustment**

Individual bass and treble controls for each zone allow tone shaping to optimize audio performance for different speakers and room acoustics.

- **Video Switching**

Matched and buffered video switching ensures perfect picture integrity from the latest high resolution video sources.

- **Four Keypads and/or Sensors per Zone**

Each remote zone can accommodate up to four keypads or wall sensors to select and operate all the available signal source components.

- **Front Panel LED Status Indicators**

Long life LED indicators show active zones, program source that has been selected and volume level in each zone.

- **RS 232 Port**

Allows for control of the CR16 with Remote Control Touch Panels and other external control systems.

- **Zone Volume Trim Adjustment**

The CR16 provides for each Zone, the adjustment of maximum Volume to compensate for differences in speaker efficiency and room acoustics.

- **Front Panel Source Selection**

The CR16 Front Panel allows for selection of the source and volume in all four zones at any time.

- **Buffered Video Outputs**

Each CR16 Video Input also has an corresponding Video Output. The Video Outputs are buffered by special Video Amplifiers to prevent signal degradation and allows the Video Signal Source to pass onto the next CR16 or the McIntosh Audio/Video Control Center.

- **Multiple Multizone Capable**

Multiple McIntosh CR16s Controllers can be connect together for additional zones. Six CR16s can provide a total of 24 independent zones.

- **Zone Control Lockout**

The CR16 has a unique control system that permits a selected zone to have access to a specific source and adjust the volume for the source, but prevents controlling the functioning for that source in that zone.

CR16 Dimensions

The following dimensions can assist in determining the best location for your CR16. There is additional information on the next page pertaining to installing the CR16 into cabinets.

Front View of the CR16



Rear View of the CR16

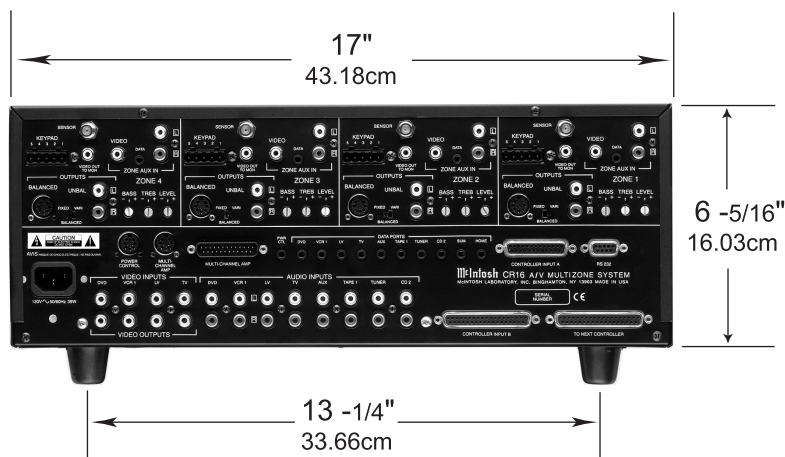

Side View of the CR16

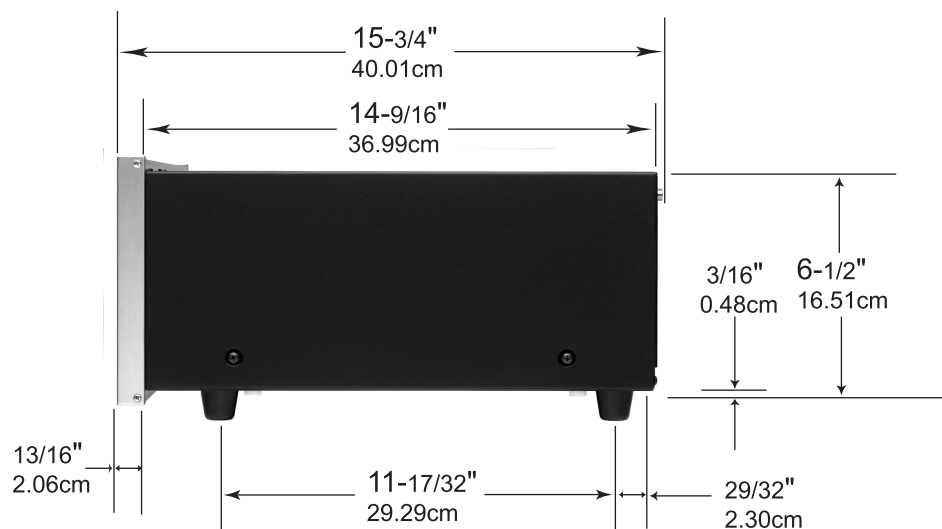

Installation

The CR16 can be placed upright on a table or shelf, standing on its four 1 inch high feet. The four feet may be removed from the bottom of the CR16 when it is custom installed as outlined below. The four feet together with the mounting screws should be retained for possible future use if the CR16 is removed from the custom installation and used free standing. It also can be custom installed in a piece of furniture or cabinet of your choice. The required panel cut-out, ventilation cutout and unit dimensions are shown.

Always provide adequate ventilation for your CR16. Cool operation ensures the longest possible operating life for any electronic instrument. Do not install the CR16 directly above a heat generating component such as a high powered amplifier. If all the components are installed in a single cabinet, a quiet running ventilation fan can be a definite asset in maintaining all the system components at the coolest possible operating temperature.

A custom cabinet installation should provide the following minimum spacing dimensions for cool

operation. Allow at least 2 inches (5.08 cm) above the top, 2 inches (5.08cm) below the bottom and 1 inch (2.54 cm) on each side of the Control Center, so that airflow is not obstructed. Allow 20 inches (50.8 cm) depth behind the front panel. Be sure to cut out a ventilation hole in the mounting shelf according to the dimensions in the drawing.

**CR16 Front Panel
Custom Cabinet Cutout**

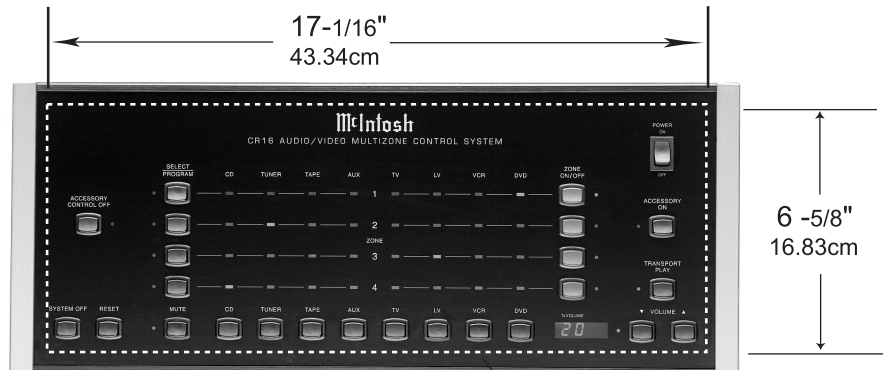

Cutout Opening for Custom Mounting

**CR16 Side View
in Custom Cabinet**

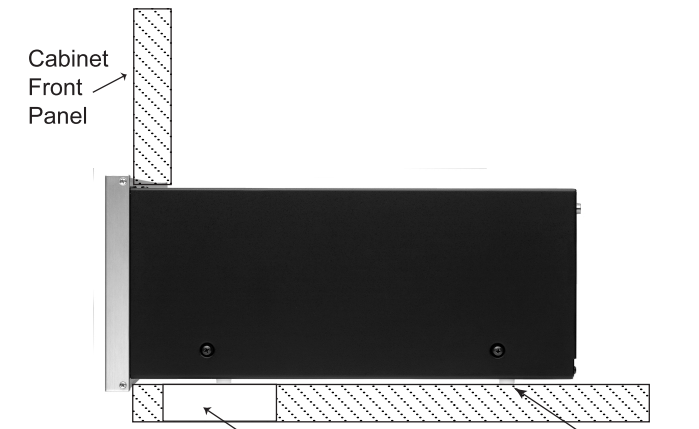

**CR16 Bottom View
in Custom Cabinet**

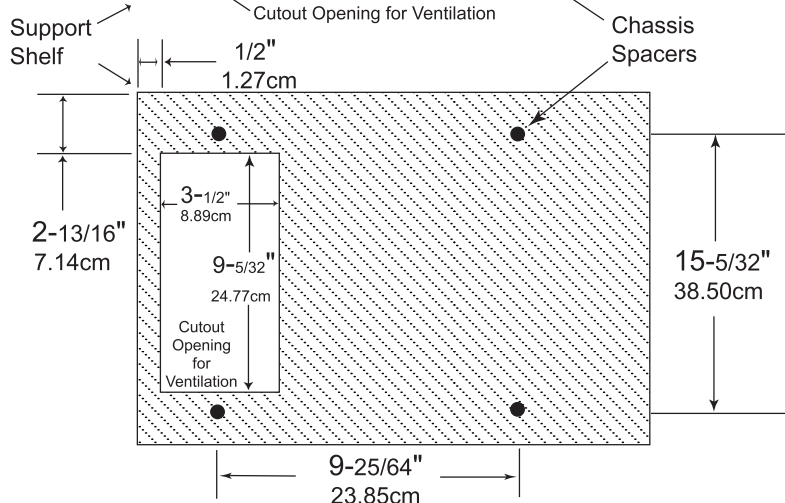

Rear Panel Controls, Connections and Switches

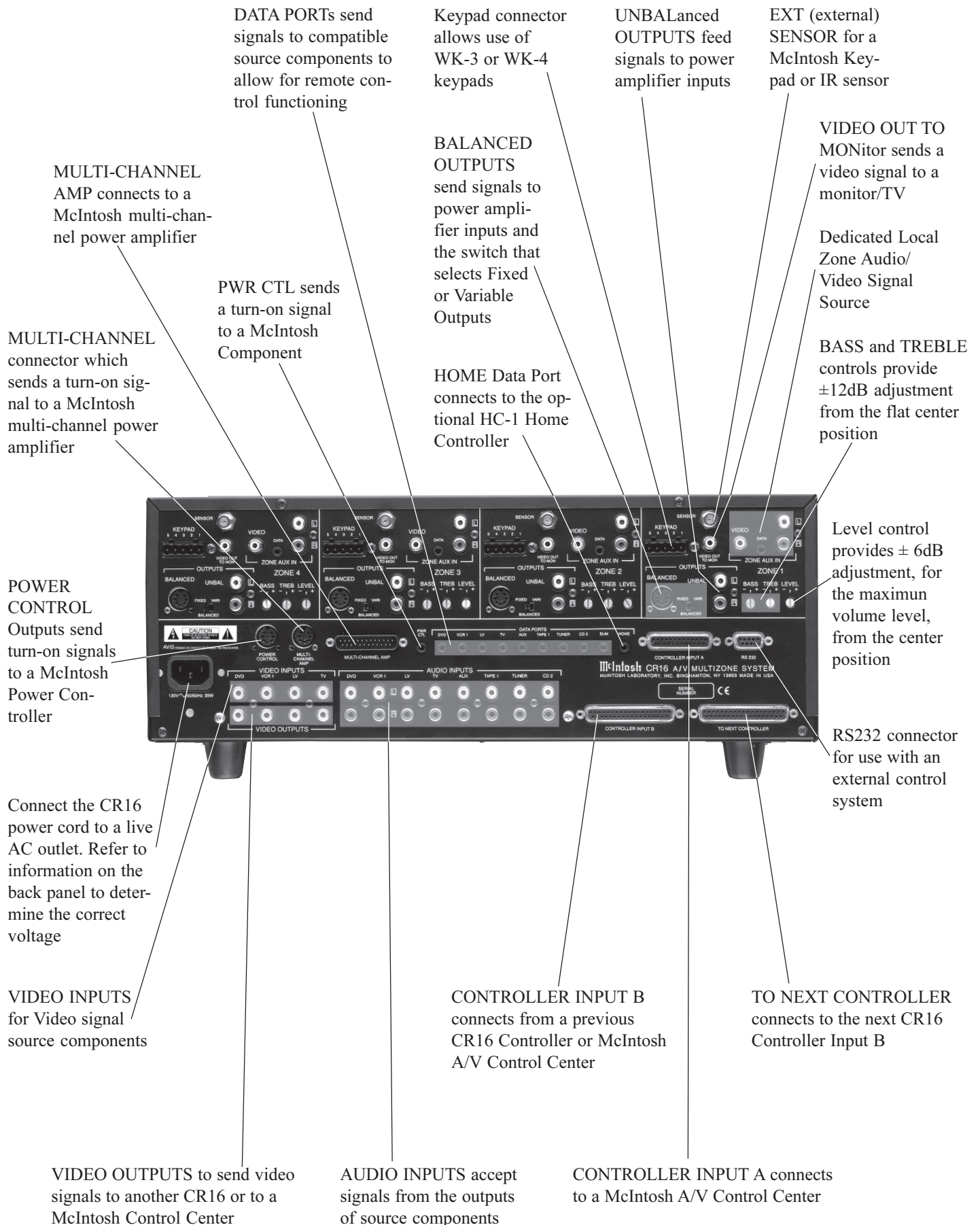

How to Connect the CR16 with a MX132

1. Connect a McIntosh Multi-Channel Amplifier with a DB25 computer type cable from the CR16 Multi-Channel Amp connector to amplifier input connector.

Note: Both audio and zone power control pass through this cable. Discrete zone audio cables may also be used, either balanced or unbalanced. Refer to page 4 for the DIN plug balanced terminal connections. Also connect a cable from the CR16 DIN Multi-Channel Amp connector to the matching connector on the amplifier to provide zone power control.

2. Connect a WK-3/WK-4 keypad, using 4 conductor shielded cable to a zone terminal connector.

Note: A WK-2 keypad or R649 Wall Sensor connected to the Zone Sensor Connector with RG6 or RG59U coax cable may also be used.

3. Connect the video outputs of A/V source components to the CR16 video inputs and the CR16 video outputs to the matching MX132 video inputs.
4. Connect the Audio Outputs from A/V source components to the matching MX132 Inputs.
5. For a dedicated Zone Source Component, connect the Audio/Video Outputs and the Data Port Input to the CR16 Zone Aux In connectors.
6. Connect the Video Out To Mon to the Video input of a remote zone TV or monitor.
7. Connect a DB37 cable from the CR16 Controller Input B Connector to the To Multizone Controller Connector on a McIntosh MX132.
8. Connect a Power Control cable from the CR16 POWER CTL (Control) jack to the Power Control In of a McIntosh Tuner.
9. Connect a Power Control cable from the McIntosh Tuner Power Control Out Jack to the Power Control In of a McIntosh DVD Player and then onto the next McIntosh Source Component.
10. Connect a Data cable from the CR16 DVD DATA PORT to the DATA IN of a McIntosh DVD Player.
11. Connect the CR16 power cord to a live AC outlet.

Monitor/TV



McIntosh Keypad

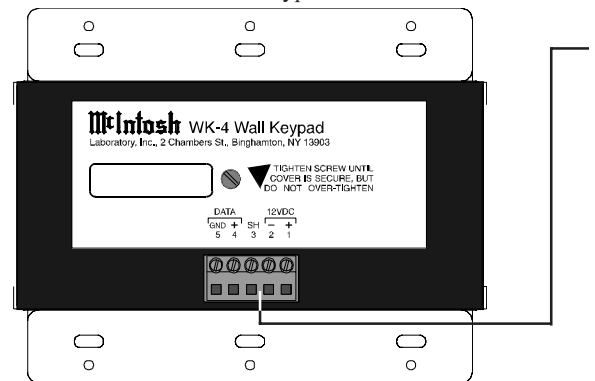

McIntosh Eight Channel Amplifier



How to Connect the CR16 with a MX132

McIntosh Tuner

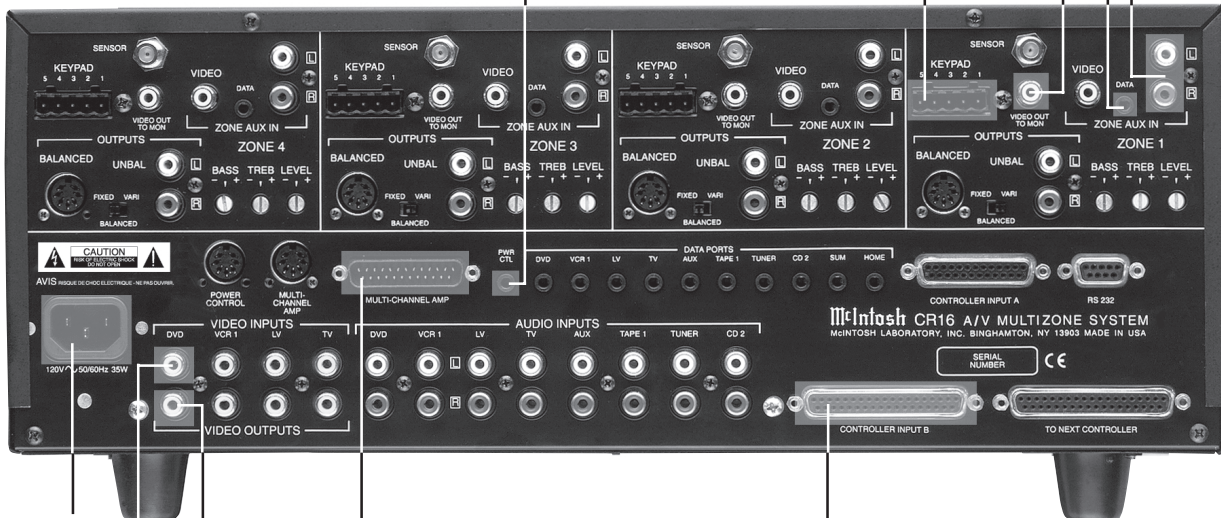
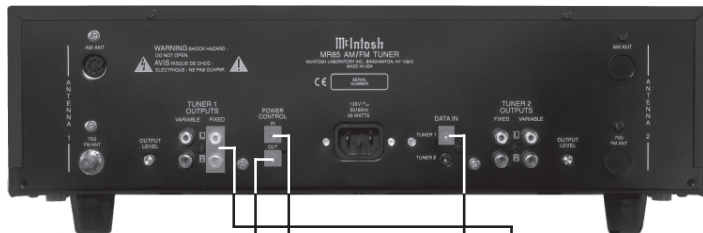

To AC Outlet

McIntosh A/V Control Center

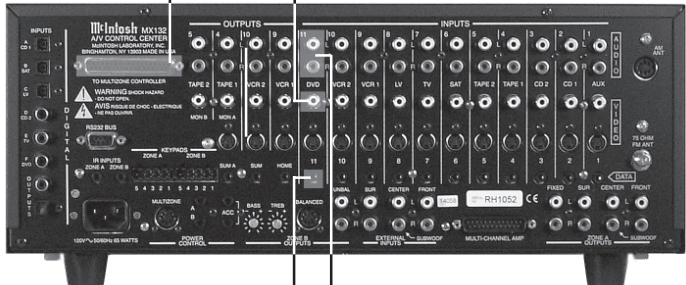

McIntosh DVD Player

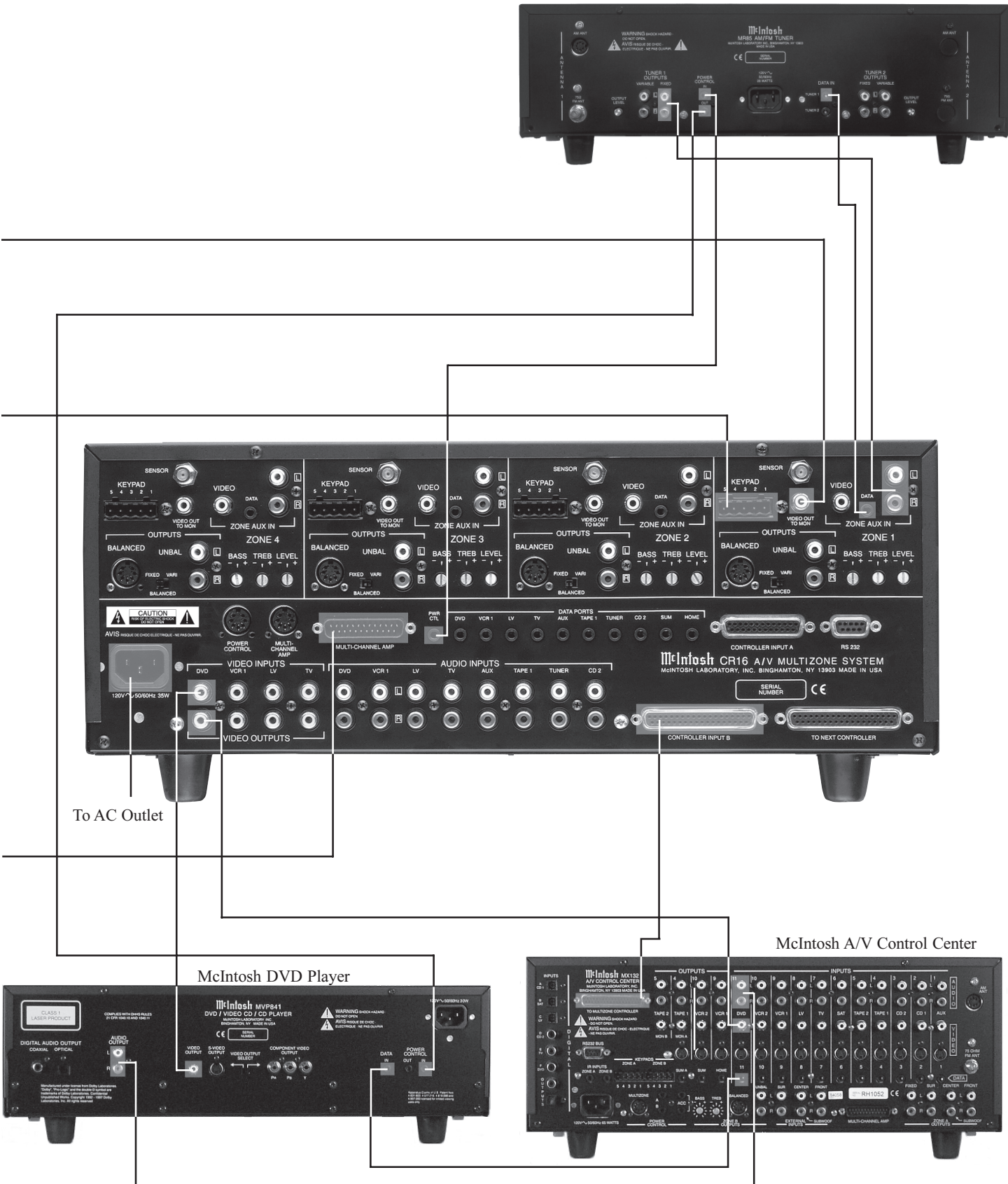

How to Connect the CR16 with a MX130/C39

1. Connect a McIntosh Multi-Channel Amplifier with a DB25 computer type cable from the CR16 Multi-Channel Amp connector to amplifier input connector.

Note: Both audio and zone power control pass through this cable. Discrete zone audio cables may also be used, either balanced or unbalanced. Refer to page 4 for the DIN plug balanced terminal connections. Also connect a cable from the CR16 DIN Multi-Channel Amp connector to the matching connector on the amplifier to provide zone power control.

2. Connect a WK-3/WK-4 keypad, using 4 conductor shielded cable to a zone terminal connector.

Note: A WK-2 keypad or R649 Wall Sensor connected to the Zone Sensor Connector with RG6 or RG59U coax cable may also be used.

3. Connect a DB25 cable from the CR16 Controller Input A Connector to the To Multiroom Controller Connector on a McIntosh MX130/C39.

Note: The DB25 cable passes only the CD2, Tuner, Tape 1 and Aux audio along with matching Data, Sys Off and Power Control signals from the control center to the CR16.

4. Connect the video outputs of A/V source components to the CR16 video inputs and the CR16 video outputs to the matching MX130/C39 video inputs.
5. Connect the Audio Outputs from A/V source components to both the CR12 and C39/MX130 inputs using a "Y" adapter if necessary.
6. For a dedicated Zone Source Component, connect the Audio/Video Outputs and the Data Port Input to the CR16 Zone Aux In connectors.
7. Connect the Video Out to Mon to the Video input of a remote zone TV or monitor.
8. Connect a Power Control cable from the CR16 POWER CTL (Control) jack to the Power Control In of a McIntosh Tuner.
9. Connect a Power Control cable from the McIntosh Tuner Power Control Out Jack to the Power Control In of a McIntosh DVD Player and then onto the next McIntosh Source Component.
10. Connect a Data cable from the CR16 DVD DATA PORT and the MX130/C39 DATA PORT to the DATA IN of a McIntosh DVD Player inputs using a "Y" adapter if necessary.
11. Connect the CR16 power cord to a live AC outlet.

Monitor/TV



McIntosh Keypad

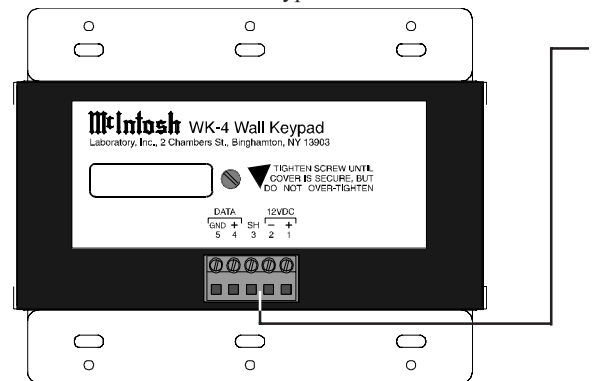

McIntosh Eight Channel Amplifier



How to Connect the CR16 with a MX130/C39

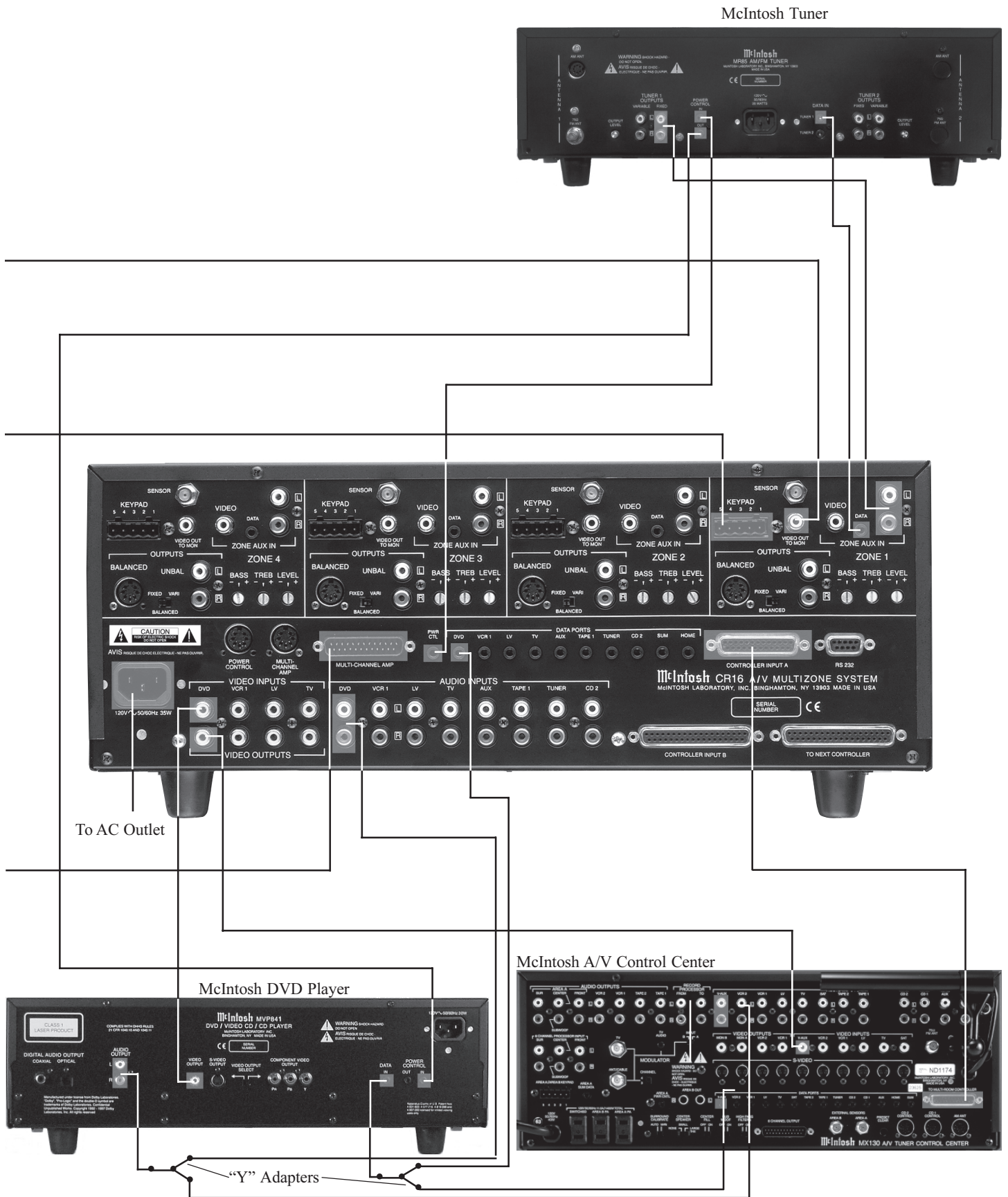

How to Connect the CR16 in a Stand Alone System

1. Connect a McIntosh Multi-Channel Amplifier with a DB25 computer type cable from the CR16 Multi-Channel Amp connector to amplifier input connector.

Note: Both audio and zone power control pass through this cable. Discrete zone audio cables may also be used, either balanced or unbalanced. Refer to page 4 for the DIN plug balanced terminal connections. Also connect a cable from the CR16 DIN Multi-Channel Amp connector to the matching connector on the amplifier to provide zone power control.

2. Connect a WK-3/WK-4 keypad, using 4 conductor shielded cable to a zone terminal connector.

Note: A WK-2 Keypad or R649 Wall Sensor connected to the Zone Sensor Connector with RG6 or RG59U coax cable may also be used.

3. Connect the Video Outputs of A/V Source Components to the CR16 Video Inputs.

5. For a dedicated Zone Source Component, connect the Audio/Video Outputs and the Data Port Input to the CR16 Zone Aux In connectors.

6. Connect the Video Out to Mon to the Video input of a remote zone TV or monitor.

7. Connect a Power Control cable from the CR16 POWER CTL (Control) jack to the Power Control In of a McIntosh Tuner.

8. Connect a Power Control cable from the McIntosh Tuner Power Control Out Jack to the Power Control In of a McIntosh DVD Player and then onto the next McIntosh Source Component.

9. Connect a Data cable from the CR16 DVD DATA PORT to the DATA IN of a McIntosh DVD Player.

10. Connect the CR16 power cord to a live AC outlet.

Monitor/TV



McIntosh Keypad

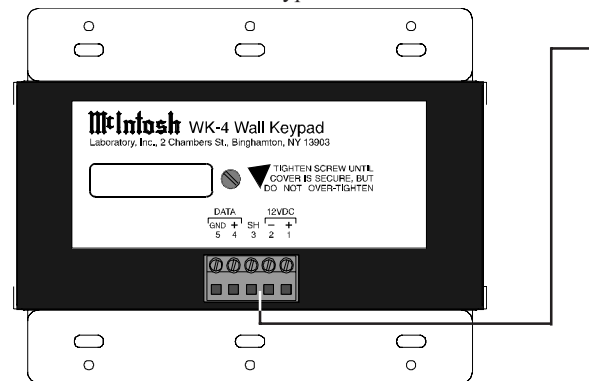

McIntosh Eight Channel Amplifier



How to Connect the CR16 in a Stand Alone System

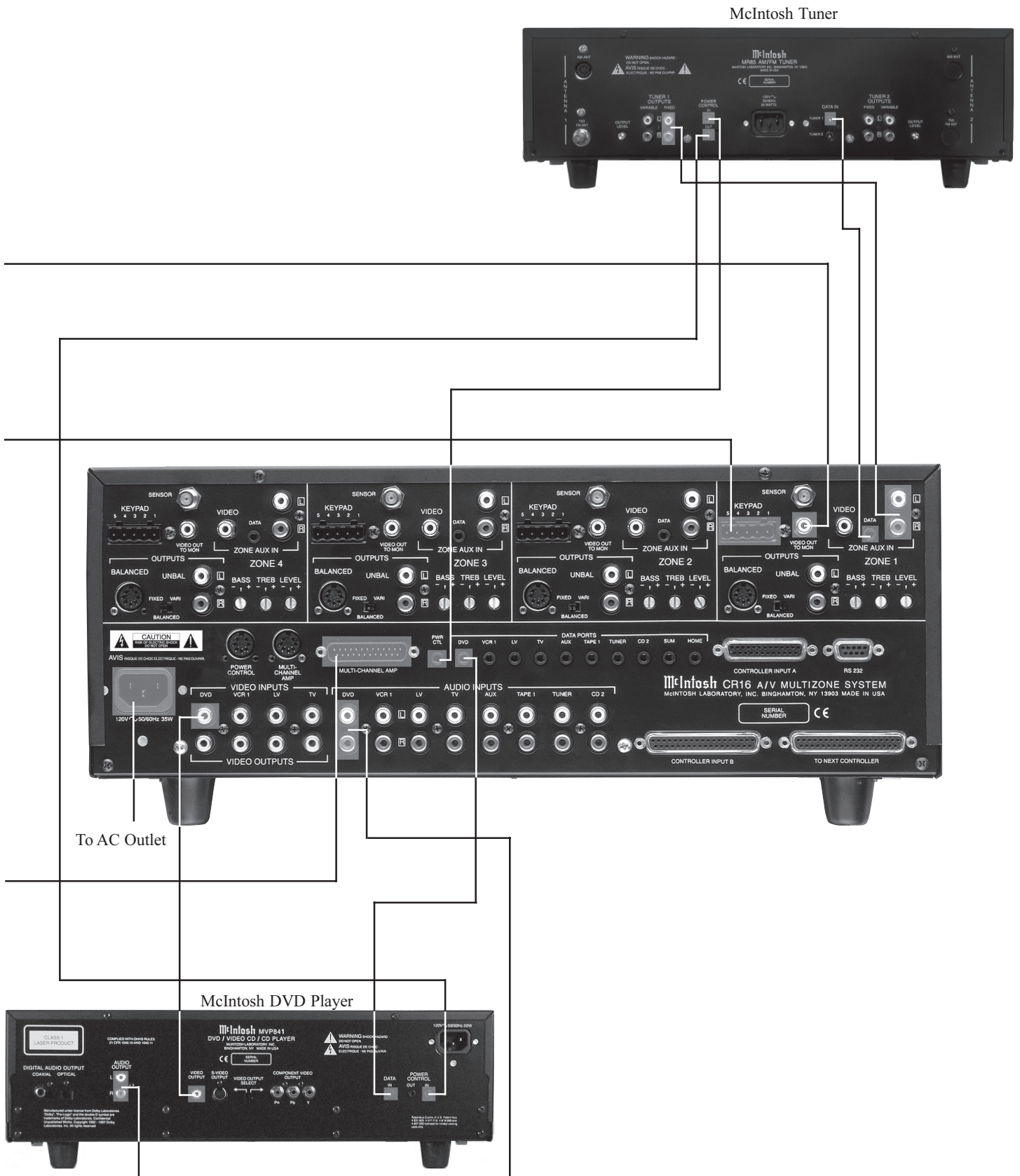

How to Connect Additional CR16s in a System

1. Connect a McIntosh Multi-Channel Amplifier with a DB25 computer type cable from the CR16 Multi-Channel Amp connector to amplifier input connector.

Note: Both audio and zone power control pass through this cable. Discrete zone audio cables may also be used, either balanced or unbalanced. Refer to page 4 for the DIN plug balanced terminal connections. Also connect a cable from the CR16 DIN Multi-Channel Amp connector to the matching connector on the amplifier to provide zone power control.

2. Connect a WK-3/WK-4 keypad, using 4 conductor shielded cable to a zone terminal connector.

Note: A WK-2 keypad or R649 Wall Sensor connected to the Zone Sensor Connector with RG6 or RG59U coax cable may also be used.

3. Connect the video outputs of A/V source components to the CR16 video inputs and the CR16 video outputs to the next CR16 video inputs.

5. For a dedicated Zone Source Component, connect the Audio/Video Outputs and the Data Port Input to the CR16 Zone Aux In connectors.

6. Connect the Video Out to Mon to the Video input of a remote zone TV or monitor.

7. Connect a DB37 cable from the CR16 Controller To Next Controller Output Connector to the Controller Input B Connector on the next CR16.

8. Connect a Power Control cable from the CR16 POWER CTL (Control) jack to the Power Control In of a McIntosh Tuner.

9. Connect a Power Control cable from the McIntosh Tuner Power Control Out Jack to the Power Control In of a McIntosh DVD Player and then onto the next McIntosh Source Component.

10. Connect a Data cable from the CR16 DVD DATA PORT to the DATA IN of a McIntosh DVD Player.

11. Connect the CR16 power cord to a live AC outlet.

Monitor/TV



McIntosh Keypad

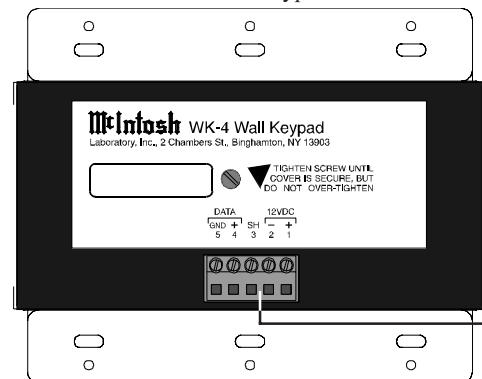

McIntosh Eight Channel Amplifier



How to Connect Additional CR16s in a System

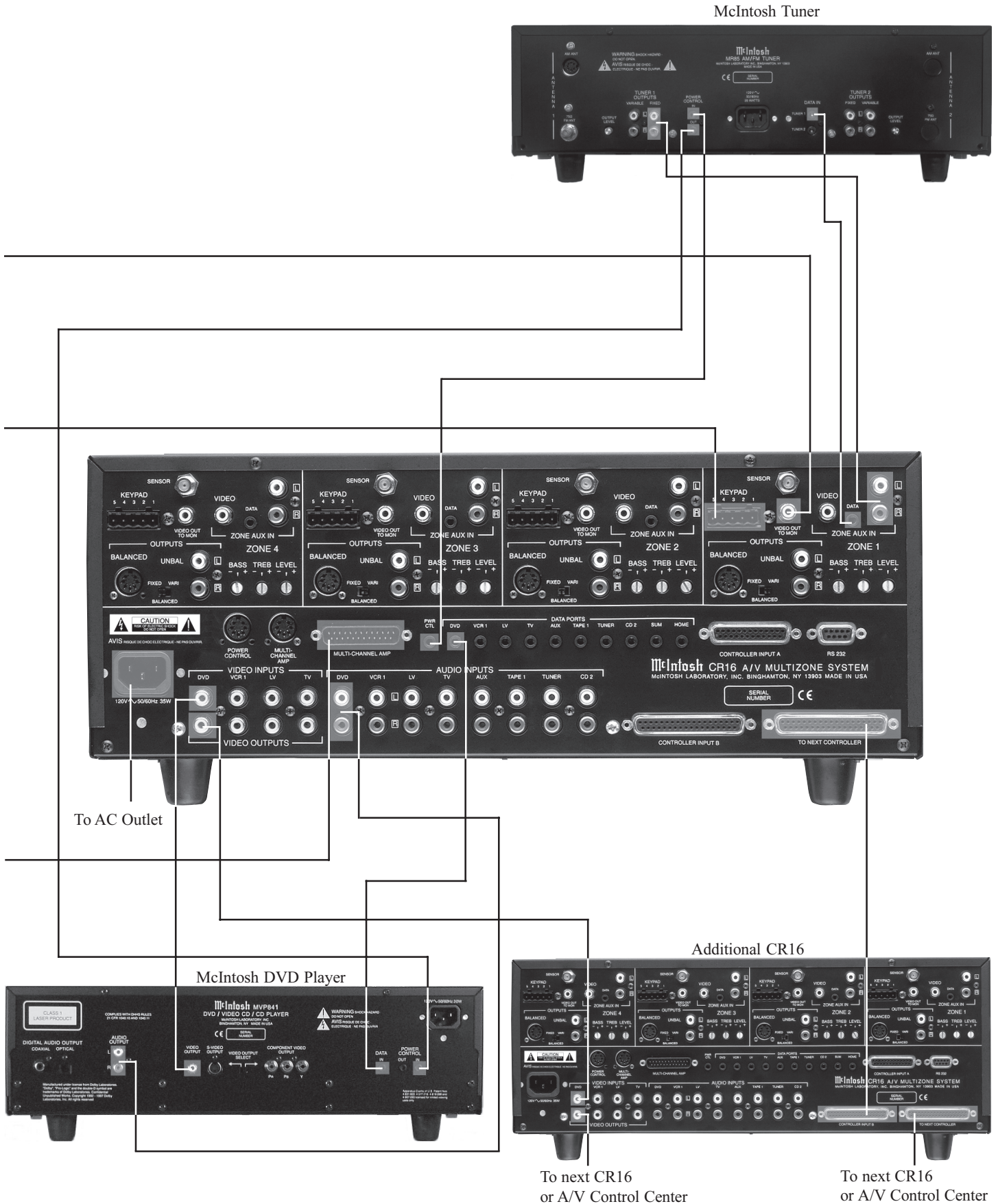

Zone 1 Locations and Settings

Location	Room Name	
1		
2		
3		
4		
Dedicated Source Component		
Component Name		
Programming		
Function Name	Yes	No
Accessory Control Off		
Accessory On		
Transport Play		
Wake-up to Last Source and Volume		
Wake-up to Same Source and Volume		
Default Source		
Default Volume		

Zone 2 Locations and Settings

Location	Room Name	
1		
2		
3		
4		
Dedicated Source Component		
Component Name		
Programming		
Function Name	Yes	No
Accessory Control Off		
Accessory On		
Transport Play		
Wake-up to Last Source and Volume		
Wake-up to Same Source and Volume		
Default Source		
Default Volume		

Zone 3 Locations and Settings

Location	Room Name	
1		
2		
3		
4		
Dedicated Source Component		
Component Name		
Programming		
Function Name	Yes	No
Accessory Control Off		
Accessory On		
Transport Play		
Wake-up to Last Source and Volume		
Wake-up to Same Source and Volume		
Default Source		
Default Volume		

Zone 4 Locations and Settings

Location	Room Name	
1		
2		
3		
4		
Dedicated Source Component		
Component Name		
Programming		
Function Name	Yes	No
Accessory Control Off		
Accessory On		
Transport Play		
Wake-up to Last Source and Volume		
Wake-up to Same Source and Volume		
Default Source		
Default Volume		

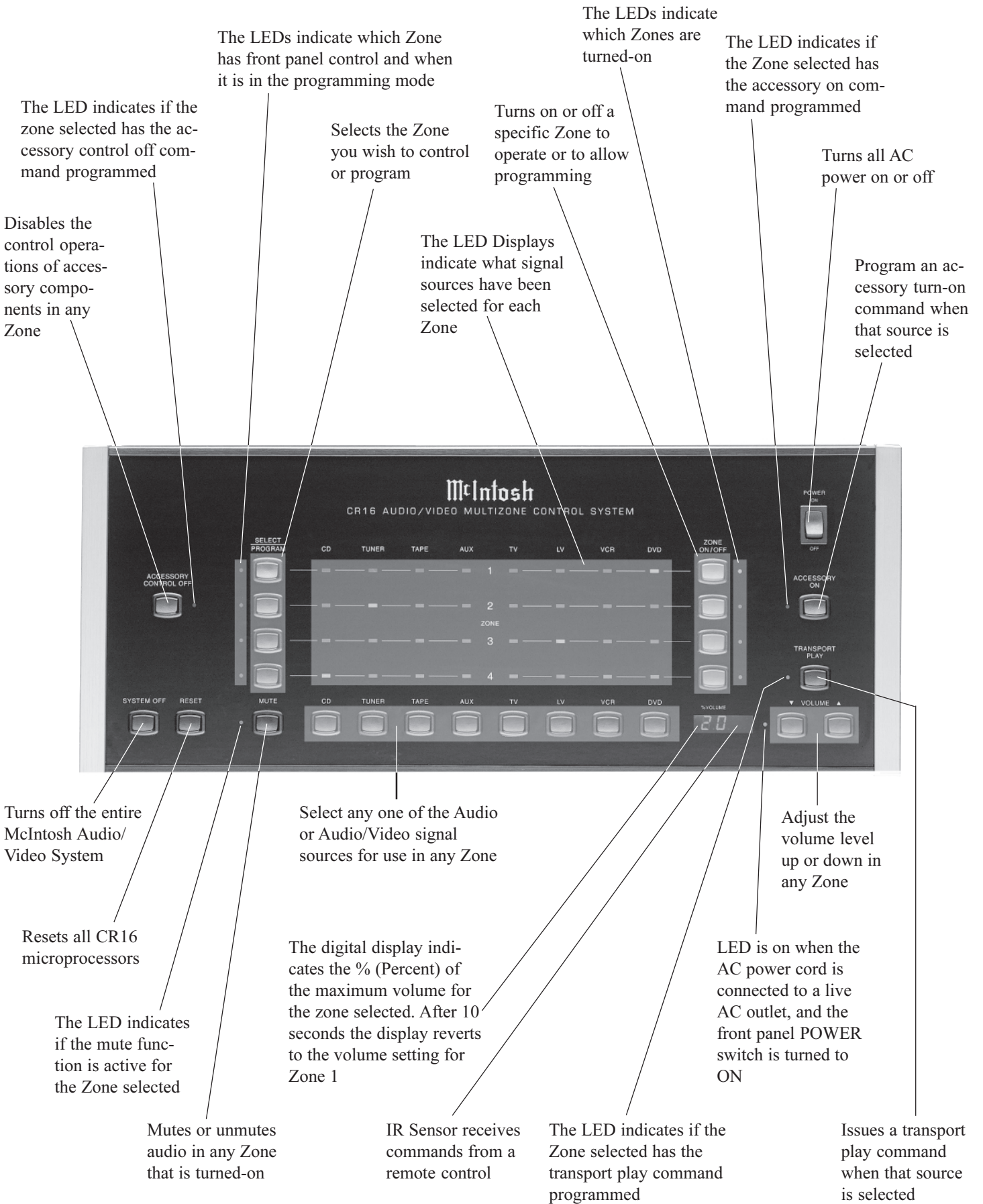

How to Operate the CR16

Power On

Press the POWER switch to ON. The Red LED, to the left of the VOLUME Down ▼ Push-button, lights to indicate the CR16 is in Standby Mode. To turn ON the CR16 press one of the ZONE ON/OFF push-buttons. Refer to figure 1.

Note: The POWER Switch is only intended to be switched OFF when the CR16 Audio/Video Multizone Control System is not used for extended periods of time, like while away on vacation. During normal operation, the POWER Switch should stay in the ON position. Press one of the ZONE ON/OFF push-buttons for turning the CR16 ON and OFF. The CR16 may also be turned ON or OFF from a McIntosh Keypad or with the supplied Remote Control.

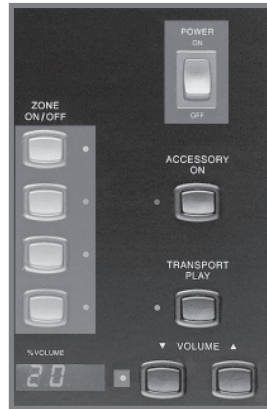

Figure 1

Zone On/Off

Turn on and operate any of the four Zones by pressing a ZONE ON/OFF Push-button. The LED to the right of the ZONE ON/OFF Push-button will illuminate to indicate that particular Zone is ON. The Zone will turn ON with the default (or programmed) signal source and volume level. Press the ZONE ON/OFF Push-button a second time to turn the Zone OFF. Refer to figure 1.

Note: If no programming has been performed, all Zones will turn ON to the Tuner Source at a volume indication of 20.

System Off

Normally, remote zones are turned on and off individually in each respective zone by pressing the Power push-button on a keypad or remote control. If you desire to turn off all zones of an entire CR16 system simultaneously, including a control center and accessory source components, you can press the Sys Off Push-button on the front panel. You can also turn off the entire system in any remote zone by pressing the Sys Off push-button on a keypad. Refer to figure 2.



Figure 2

Note: Individual remote zones should normally be turned off with the Power Push-button since there may be other zones in use.

Select/Program

The SELECT/PROGRAM Push-buttons allow for two dif-

ferent functions for each Zone of the CR16. When a Zone is first turned ON, the LED to the left of the SELECT/PROGRAM Push-button will flash On and Off for about 10 seconds indicating the SELECT Mode is active for that Zone. During this period of time, Source Selection, Volume changes and Volume Muting are possible. At any time when a given Zone is ON, Source Selection, Volume changes and Volume Muting can be made by first pressing the SELECT/PROGRAM Push-button followed by selecting a different source, muting and/or volume level for that Zone. Pressing the SELECT/PROGRAM Push-button a second time, during that 10 second period of time, the control of that Zone will switch Off. Refer to page 22 for information on programming the CR16.

Note: Ten seconds after Zones 2, 3 or 4 are turned ON, all front panel operating functions return to Zone 1 after 10 seconds even if Zone 1 is not active. For information on programming refer to page 22.

Dedicated zone source components

If a specific CR16 zone has a source component dedicated exclusively to that zone, it can be operated in that zone with a keypad or remote control. When a dedicated zone source component is connected, it replaces the source component that is connected to the CR16 Aux inputs. If the CR16 is connected with a Control Center which has a source component connected to its Aux inputs, that component will not be available in the zone with the dedicated source component.

Bass, Treble and Level Controls

Adjust the bass and treble controls for the desired tone shaping in each zone. Adjust the zone level controls to increase or decrease a maximum of 6dB from the center detent position. Volume changes with the level controls add or subtract from the turn on levels. Refer to figure 3.

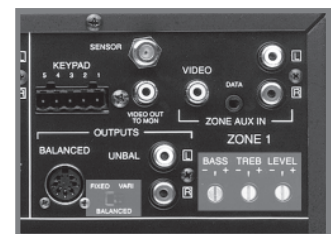

Figure 3

Balanced and UnBalanced Outputs

Place the slide switch to the correct position according to the output hook-up, balanced or unbalanced connections.

Reset of Microprocessors

In the event that the controls of the CR16 stop functioning, there is a user reset function built in. Press the Reset push-button and this will reset the CR16 microprocessors. Refer to figure 2.

How to Operate in Remote Zones

Power

Press the Power push-button and the Zone will turn-on with either the default or programmed signal source and volume level. Press the Power push-button a second time to turn the Zone OFF.

Note: Operations in remote Zones can be performed by pressing a push-button on a keypad or remote control. Refer to figures 4 and 5. The Remote Control Push-buttons that are highlighted in white are for use with other McIntosh Control Centers.



Figure 4

Source Selection

Select and operate any available signal source by pressing the appropriate Keypad or Remote Control Push-button.

Volume

The Turn-On Volume Level can be changed by pressing an UP ▲ or DOWN ▼ Volume Push-button.

System Off

Normally remote Zones are turned On and Off individually in each respective Zone by pressing the Power Push-button on a Keypad or Remote Control. If you desire to turn off the entire McIntosh Audio/Video System you can press the SYS Off Push-button.

Note: Individual Remote Zones should normally be turned Off with the Power Push-button since there may be other Zones in use that would automatically be turned Off by the Sys OFF Push-button in a Specific Zone.

Dedicated Zone Source Components

If a specific CR16 Zone has a Source Component dedicated exclusively to that Zone, it can be operated with a

Keypad or Remote Control. When a dedicated Zone Source Component is connected, it replaces the source component that is connected to the CR16 Aux Input. If the CR16 is connected with a Control Center which has a Source Component connected to its Aux Input, that component will not be available in the Zone with the Dedicated Source Component.

Introduction to Programming

The default setting for each Zone is to turn-on with the Tuner as the Source and a Volume Level of 20. You can change the default setting to any of CR16 Inputs at the desired volume level. It is also possible to have a Zone turn-on with the Last Selected Source and Volume Level Setting. A Power-On and Play Command can also be programmed for a compatible source component so that it occurs when the Zone is first turned-on. It is also possible to prevent the Control of a Selected Source for a given Zone yet allow listening and/or viewing of that source. All programming is stored in permanent memory and is retained until changed, even in the event of a power failure. Refer to figure 6.

Note: In order to Program a Zone for any function, it first must be switched OFF.

Setting the same source and volume level

1. Press the Program Push-button for the Zone you wish to program. The LED next to the selected Zone will turn-on with a constant indication.
Note: After pressing a Program push-button, you must make any changes with 10 seconds of each other. After the 10 seconds, the programming for that Zone will turn Off.
2. Select a Source for that Zone by pressing any of the eight Source Push-buttons and the selected source front panel LED will turn-on. This will become the active Source whenever that Zone is first turned-on.
3. Press an Up ▲ or Down Volume ▼ Push-button to select the desired volume level in that Zone. The Front Panel Display will indicate the selected level.
4. Press Program Push-button again or wait 10 seconds to exit the programming mode.

Setting the last selected source and volume level

1. Press the Program Push-button for the Zone you wish to program. The LED next to the selected Zone will turn-on with a constant indication.
Note: After pressing a Program Push-button, you must make any changes within 10 seconds of each other. After the 10 seconds, the programming for that Zone programming will turn Off.



Figure 5

2. Press the Source Push-button, whose LED is currently illuminated. The entire row of Front Panel Source LED's for that Zone will turn-off.
3. Press Program Push-button again or wait 10 seconds to exit the programming mode. The next time that Zone is turned-on it will come on with the last selected source and volume level.

Accessory Power On or Off

1. Press the Program Push-button for the Zone requiring the Accessory Control On Function.
2. Press Accessory Control On to program a turn on signal. The LED next to the Accessory On Push-button will Turn-On to indicate accessory on command has been selected.
3. Press Program Push-button again or wait 10 seconds to exit the programming mode.

Note: If the Accessory Control is already on just repeat the above procedures to turn off the feature. The accessory source component must have a Data cable interconnected with the CR16 in order to receive the turn-on command and must also have a power switch that automatically cycles off when AC power is removed.

Transport Play

1. Press the Program Push-button for the Zone requiring a Transport Play Command.
2. Press the Source Push-button that requires the Transport Play Command.

3. Press the Transport Play Push-button. The LED next to the Transport Play Push-button will Turn-On to indicate the Transport Play Command has been selected.

Note: If Accessory Power On is used in combination with Transport Play Command there is a 2 second time delay between the two commands.

4. Press Program Push-button again or wait 10 seconds to exit the programming mode.

Accessory Control Off

1. Press the Program Push-button for the Zone requiring Accessory Control Off.
2. Press the Accessory Control Off Push-button. The Red LED to the right of the Accessory Control Off Push-button will turn ON to indicate that the Control function is Turned OFF for that Zone.
3. Press Program Push-button again or wait 10 seconds to exit the Programming Mode.

Programming with a Keypad or Remote Control

1. Press the Source Push-button for the desired new Source.
2. Press an Up ▲ or Down ▼ Volume Push-button to select the desired volume level in that Zone.
3. Press and hold the new Source Push-button for 3 seconds. The zone audio will mute, indicating that the change has occurred. Release the push-button to unmute. The next time that Zone is turned on, the new signal source and volume level will be in effect.



Figure 6



Note: The Remote Control push-buttons that are highlighted in white are for use with other McIntosh Control Centers.

The supplied remote control is capable of directly controlling the functions of contemporary McIntosh Source Components connected to the CR16. Earlier McIntosh source components and other brand source components can be controlled by the CR16 with the addition of a McIntosh Remote Control Translator (RCT).

Note: Your McIntosh Dealer can assist you with the installation and operation of the Remote Control Translator (RCT).

Mute

Press the MUTE push-button to mute audio at the active Zone.

Input Source Selection

Press any of the eight input push-buttons to select a Audio/Video Source.

CD/Tape Functions

Use these push-buttons to operate a CD player, CD changer or tape recorder.

Numbered Push-buttons

Press push-buttons 0 through 9 to access tuner station presets or CD tracks/discs.

Disc and Track

Use the DISC and TRACK push-buttons when a CD player or changer is being used.

Tuner Push-buttons

Press the AM or FM push-button to select the desired broadcast band. Press and release the Channel Up▲ or Down▼ push-button to move from station to station. Press and hold a Channel Up▲ or Down▼ push-button to move continuously from station to station. Press REVIEW Push-button to start the automatic brief audition of each of the presets stored in the tuner memory. Press REVIEW a second time to stop on a station preset and exit the review process.

Volume

Press the Up or Down VOLUME push-button to raise or lower the listening volume level.

Acc On

Press ACC ON to turn the power ON to a McIntosh Disc Player.

Acc Off

Press ACC OFF to turn the power OFF to a McIntosh Disc Player.

E

Press E to perform various functions on a variety of McIntosh Components. It will also pause the playing of a disc or tape player.

Lighting

Press and release the LIGHTING push-button to momentarily illuminate the upper half of the remote control push-buttons.

Note: While the LIGHTING push-button is being depressed, the remote control will be unable to send a remote command. When the LIGHTING push-button is released, the push-buttons will continue to stay illuminated for approximately three seconds thus allowing you to send the desired command.

Specifications

Frequency Response

+0, -0.5dB from 20Hz to 20,000Hz

Maximum Voltage Output

6Volts

Total Harmonic Distortion

0.01% From 20Hz to 20,000Hz

Sensitivity

250mV for 1.5V rated output

Signal To Noise Ratio

90dB below rated output, (A Weighted)

Maximum Input Signal

8Volts

Input Impedance

22K ohms

Output Impedance

600 ohms, Balanced and Unbalanced

Tone Controls

+12dB, -12dB from center detent position

Voltage Gain

Input to Variable Outputs, 14dB

Input to Fixed (Balanced) Outputs, 0dB

Power Requirements

100 Volts, 50/60Hz at 25 watts

110 Volts, 50/60Hz at 25 watts

120 Volts, 50/60Hz at 25 watts

220 Volts, 50/60Hz at 25 watts

230 Volts, 50/60Hz at 25 watts

240 Volts, 50/60Hz at 25 watts

Note: Refer to the rear panel of the CR16 for the correct voltage

Overall Dimensions

17-1/2 inches (44.5cm) W, 7-1/16 inches (17.9cm) H, 20 inches (50.8cm) D, (including clearance for connectors)

Weight

27.2 pounds (12.2 Kg) net, 39.5 pounds (18 Kg) in shipping carton

Packing Instructions

In the event it is necessary to repack the equipment for shipment, the equipment must be packed exactly as shown below. It is very important that the four plastic feet are attached to the bottom of the equipment. This will ensure the proper equipment location on the bottom pad. Failure to do this will result in shipping damage.

Use the original shipping carton and interior parts only if they are all in good serviceable condition. If a shipping carton or any of the interior part(s) are needed, please call or write Customer Service Department of McIntosh Laboratory. Please see the Part List for the correct part numbers.

Quantity	Part Number	Description
1	033762	Shipping carton only
2	033763	End Cap
1	033620	Inside carton only
1	033726	Top Pad
1	033729	Bottom pad
4	018578	Plastic foot
4	100159	#10-32 x 3/4" screw
4	104080	#10 Flat washer
1	047920	Shipping carton complete with all the above parts

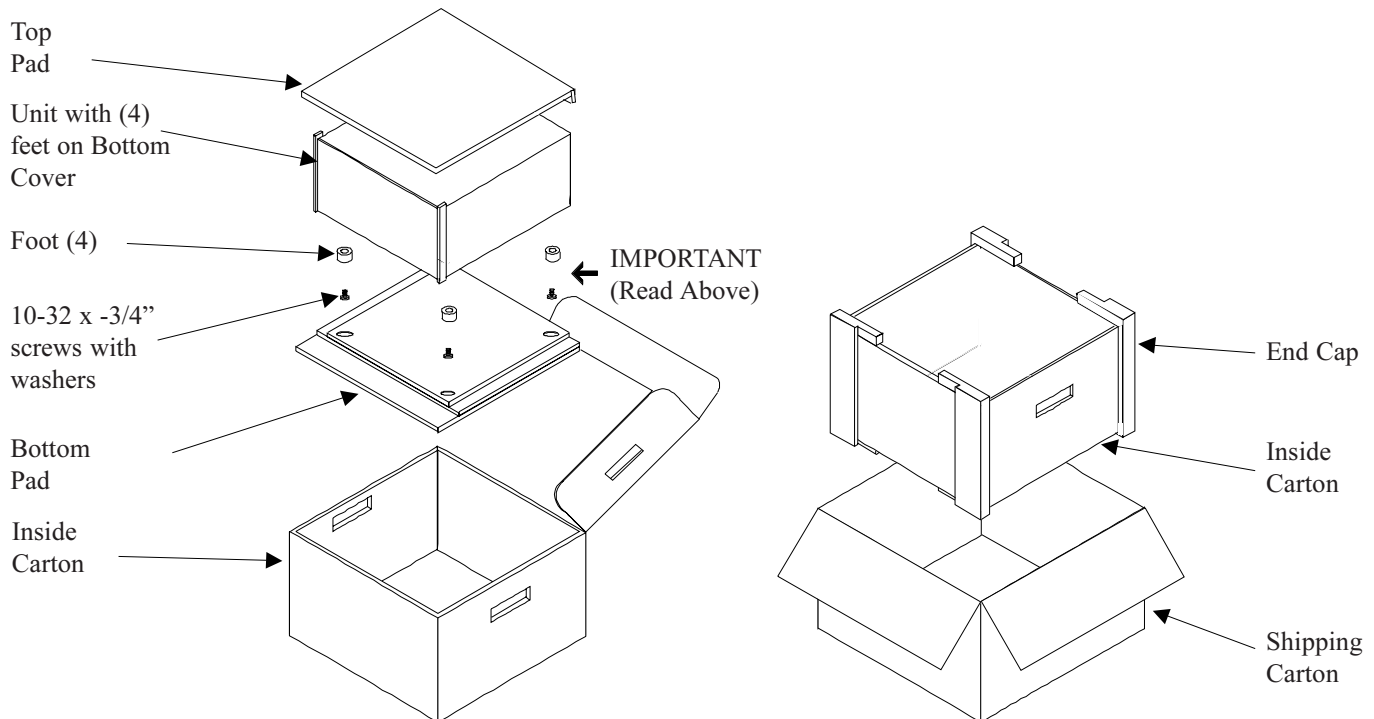

McIntosh[®]

McIntosh Laboratory, Inc.
2 Chambers Street
Binghamton, NY 13903

McIntosh Part No. 040728